

RECOMMENDED SOLDERING PCB LAYOUT
TOLERANCE(.XX±0.05)

- Note:
- Material: Titanium Copper Thickness 0.08mm
 - Electroplate:
Au >1u" on contact area
Au >1u" on solder area
Nickel underplating over all
 - Electrical Characteristics:
3-1 Current Voltage: 12V
3-2 Current Rate: 3A
3-3 Contact Resistance: Normal Compression <30mΩ
 - Working Range of Application: 0.30-0.60 mm
 - Spring Force Tolerance is ± 20gf
 - Operating Temperature: -20°C ~ +85°C

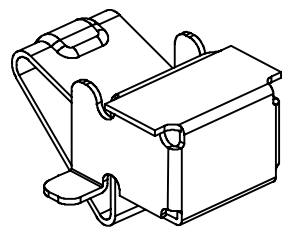

| | | | |
|-----------------------|-----------|-----------------------|----------------------------|
| 00 | 12/25-'15 | Design creation | |
| REV | Date | Description | |
| DRAFT Danny Liao | | DATE 12/25-'15 | RoHS Compatible |
| CHECKER Justin Wu | | DATE 12/25-'15 | |
| APPROVAL Jacky Lin | | DATE 12/25-'15 | SHEET 1-2 |
| | | SCALE Not to scale | UNIT mm |

| TOLERANCE/CLASS | | | |
|-----------------|--------|------|------|
| RANGE(mm) | 1 | 2 | 3 |
| 30 < | ± 0.10 | 0.15 | 0.20 |
| 30 < - 120 | ± 0.15 | 0.20 | 0.30 |
| 120 < - 300 | ± 0.20 | 0.30 | 0.50 |
| 300 < | ± 0.30 | 0.50 | 0.80 |
| ANGLES | ± 2.5° | | |

EMI STOP CORP.
EMI STOP

EMISTOP JC-323020G CUS P/N

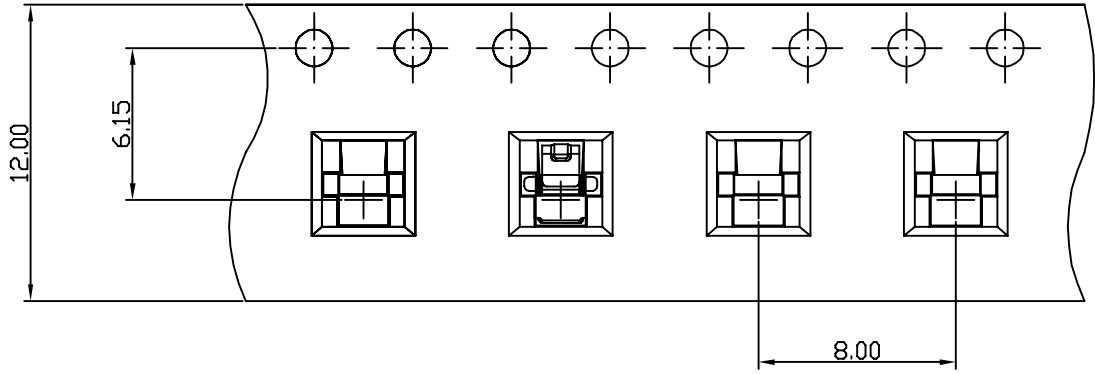
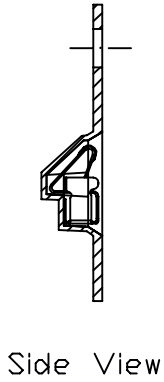

FEEDING DIRECTION

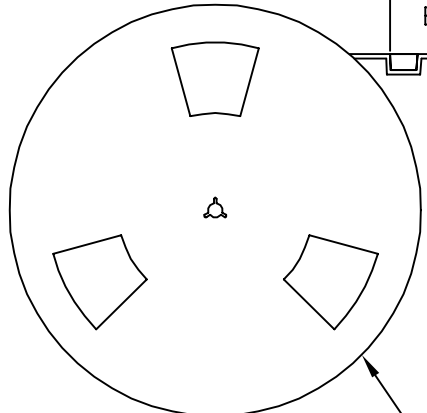
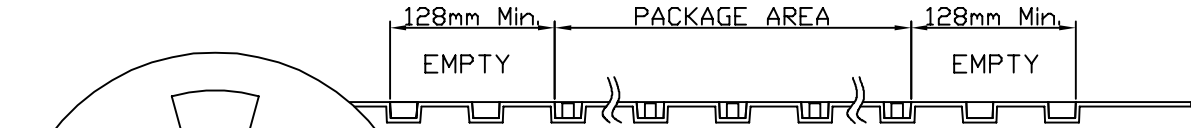
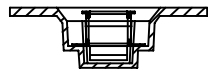

REEL(13")

Package Information:
 1.Quantity Per Reel: 3400PCS
 2.REEL: 13"X 12 mm

| | | | | |
|----------|-----------|-----------------|----------------------------------|------|
| 00 | 10/24-'19 | Design creation | | |
| REV | Date | Description | | |
| DRAFT | Andy □ | DATE | RoHS Compatible | |
| CHECKER | Justin Wu | DATE | | |
| APPROVAL | Jacky Lin | DATE | | |
| | 10/24-'19 | SHEET | SCALE | UNIT |
| | 10/24-'19 | 2-2 | Not to scale | mm |

| TOLERANCE/CLASS | | | |
|-----------------|-------|------|------|
| RANGE(mm) | 1 | 2 | 3 |
| ≤30 | ±0.10 | 0.15 | 0.20 |
| 30<- ≤120 | ±0.15 | 0.20 | 0.30 |
| 120<- ≤300 | ±0.20 | 0.30 | 0.50 |
| 300< | ±0.30 | 0.50 | 0.80 |
| ANGLES | ±2.5° | | |

EMI STOP CORP.
 EMI STOP
 EMISTOP JC-323020G
 CUS P/N